

Controls & Features

Ignition Switch

The ignition switch (1) is used for starting and stopping the engine (page 47). Insert the key and turn it to the right for the ON (|) position.

Key Position	Function
ON ()	Electrical circuits on.
OFF (O)	No electrical circuits function.

CENTRE OF HANDLEBAR

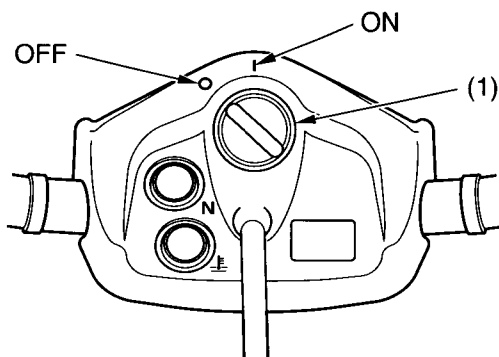

(1) ignition switch

| ON
O OFF