

Fuel Fill Cap

After refueling, be sure to tighten the fuel fill cap (Fig. 2-19) until it clicks.

Insert the breather tube (2) into the handlebar cover hole (3).

To refuel refer to page 88.

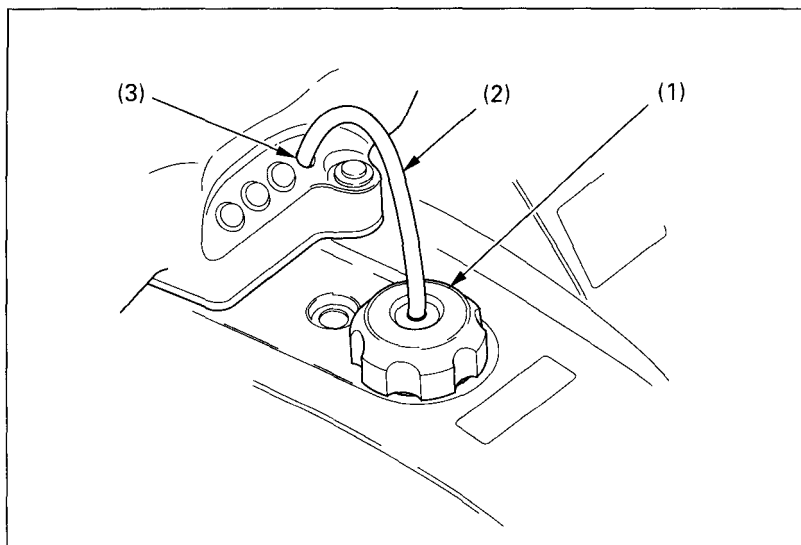

Fig. 2-19 (1) Fuel fill cap

(2) Breather tube
(3) Handlebar cover hole