

SIDE COVER

Removal:

1. Remove the front seat. (see page 41)
2. Open the rear seat. (see page 42)
3. Remove the bolts (1).
4. Remove the screws (2).
5. Remove the clips (3).
6. Remove the side covers (4) by pulling them toward you.

Installation:

1. Installation can be done in the reverse order of removal.

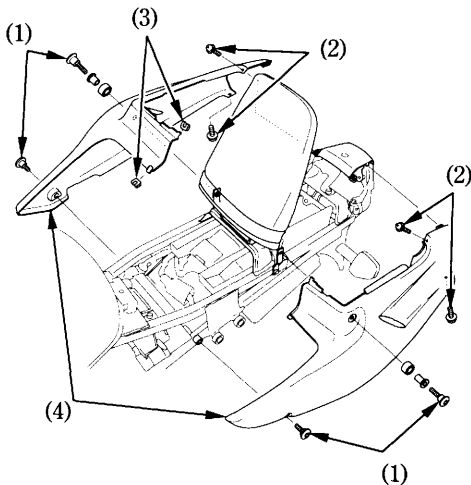

- (1) Bolts
(2) Screws

- (3) Clips
(4) Side cover