

Wear Inspection:

Check the chain wear label when adjusting the chain. If the red zone (1) on the label aligns with the index mark (2) on the chain adjuster plate after the chain has been adjusted to the proper slack, the chain is excessively worn and must be replaced. The proper slack is:

30–40 mm (1.2–1.6 in)

Damage to the bottom part of the frame may be caused by excessive drive chain slack of more than:

50 mm (2.0 in)

Replacement chain:

DID 525HV

or

RK 525ROZ6

This motorcycle has a staked master link drive chain which requires a special tool for cutting and staking. Do not use an ordinary master link with this chain. See your Honda dealer.

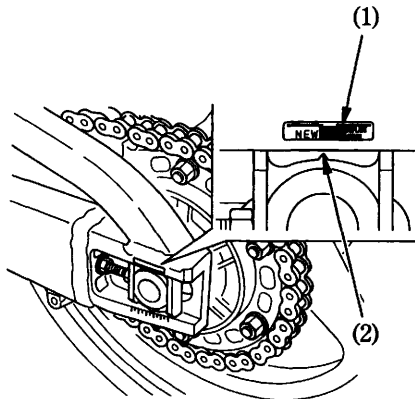

(1) Red zone

(2) Index mark