

WHEEL REMOVAL

(Refer to the maintenance precautions on page 70).

Front Wheel Removal

1. Raise the front wheel off the ground by placing a support block under the engine.
2. Cover both sides of the front wheel with a protective tape (1) or equivalent.

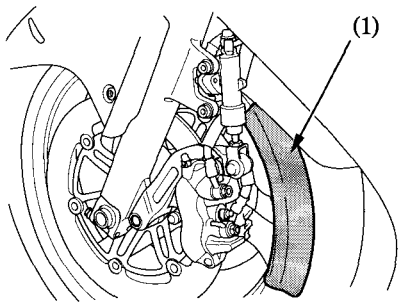

(1) Protective tape

3. Remove the two A socket bolts (2) and the B socket bolt (3).

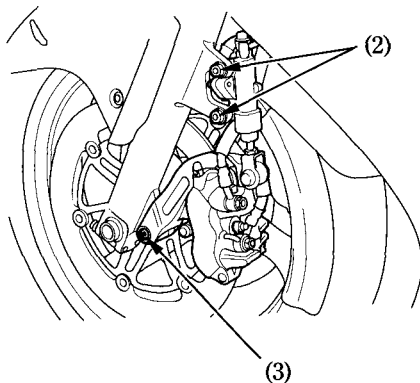

(2) Socket bolts A

(3) Socket bolt B