

Fuse Box:

The fuse box (1) is located under the front seat.

The specified fuses are:

10A, 20A

1. Remove the front seat (page 81).

2. < CBR1000RR >

Release the tabs (2), then remove the fuse box cover (3).

< CBR1000RR ABS >

Release the tabs by pushing the front tab backward, then remove the fuse box cover.

3. Pull out the old fuse and install a new fuse. The spare fuses (4) are located in the fuse box.

4. Install the fuse box cover and install the front seat.

< CBR1000RR >

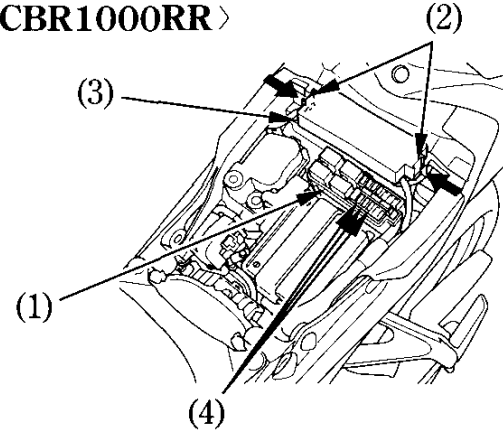

< CBR1000RR ABS >

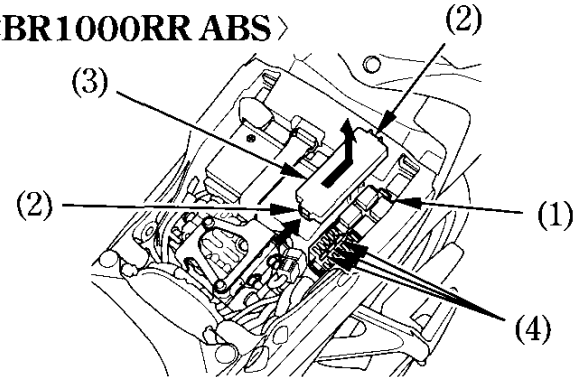

(1) Fuse box

(2) Tabs

(3) Fuse box cover

(4) Spare fuses